

AUSTRALIA / NEW ZEALAND

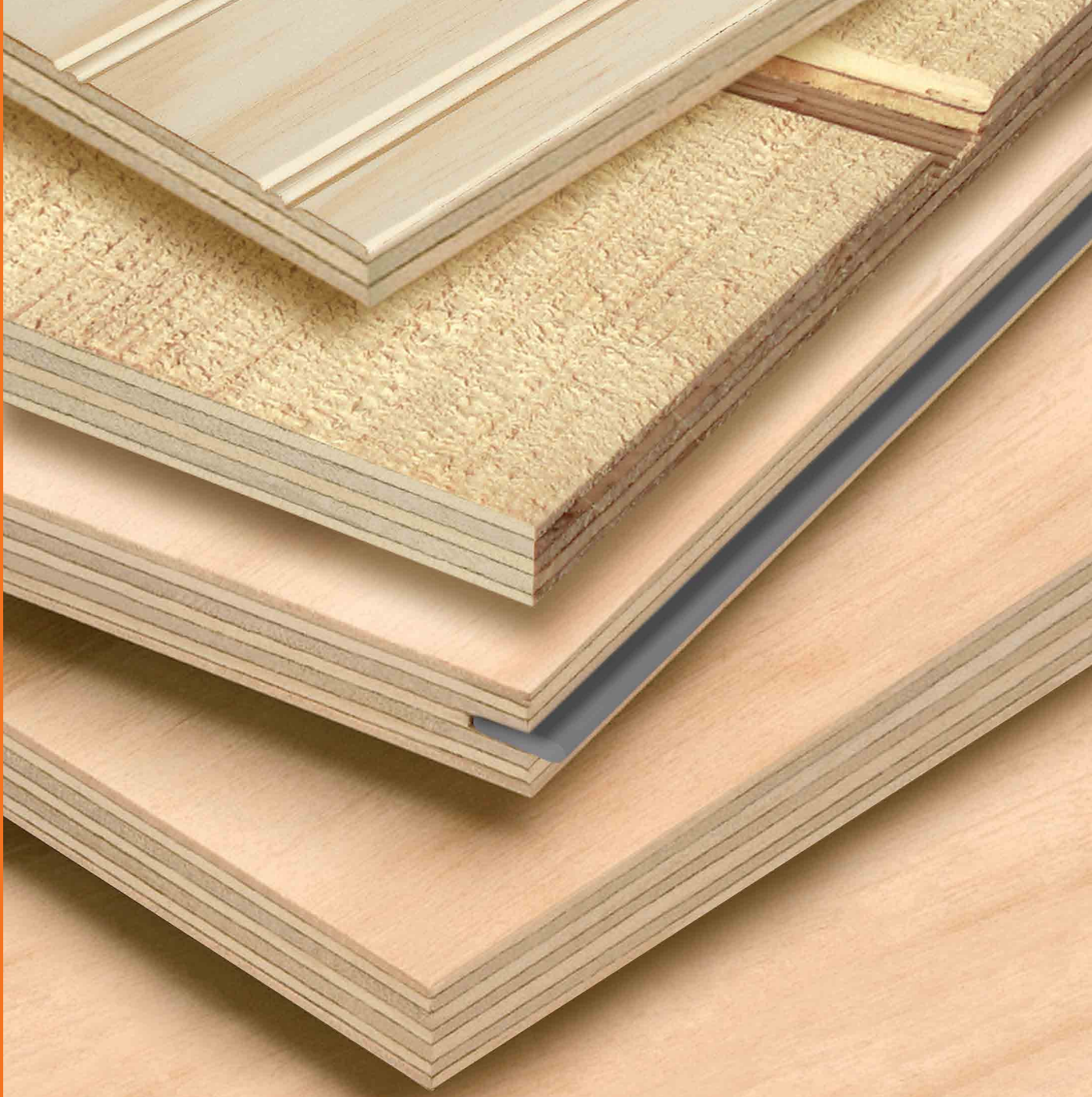

## Product Catalogue



# ARAUCOPLY™

*MORE THAN JUST A PRETTY FACE™*



**ARAUCO**  
Growing the Future

## Contents

<b>ARAUCO</b>	4
<b>A Global Leader</b>	4
<b>ARAUCO's Areas</b>	4
<b>ARAUCO Worldwide</b>	5
<b>Sustainability</b>	6
Environmental Responsibility	6
Occupational Health and Safety of Our Workers	7
Social Development and Welfare of Communities	7
<b>PLYWOOD PRODUCTS</b>	8
<b>Certifications</b>	8
<b>Product Range</b>	9
CD Structural	10
DD Structural	10
Structural Flooring	11
Structural Roofing	11
Cladding	12
Appearance & Lining Grades	14
Non-Structural	15
<b>Technical information</b>	16
Species	16
Moisture Content	16
Adhesives & Emissions	16
Glue Bond	16
Dimensional Properties	17
Structural Properties	17
Span Ratings Flooring	19
Span Ratings Roofing	20
Bracing Ratings	21
Thermal Conductivity	22
Fire Tests on Building Materials	22
Fixings and Adhesives	22
Product Identification	23
Storage and Handling	23
<b>FAQ</b>	24
<b>LIMITATIONS</b>	27

“Growing means being a global leader in the development of sustainable products”

ARAUCO is much more than just a forestry company. ARAUCO is a comprehensive business that generates employment, produces quality goods and provides clean energy; while furthering the development of workers and communities; creating educational and cultural opportunity in impoverished communities; and promoting research, insight, innovation, and respect for our environment.

As it looks to the future, ARAUCO continues to demonstrate its day-by-day commitments: superior service to customers and stakeholders; workplace enhancement; positive contribution to the communities in which it operates; and environmentally responsible resource management.

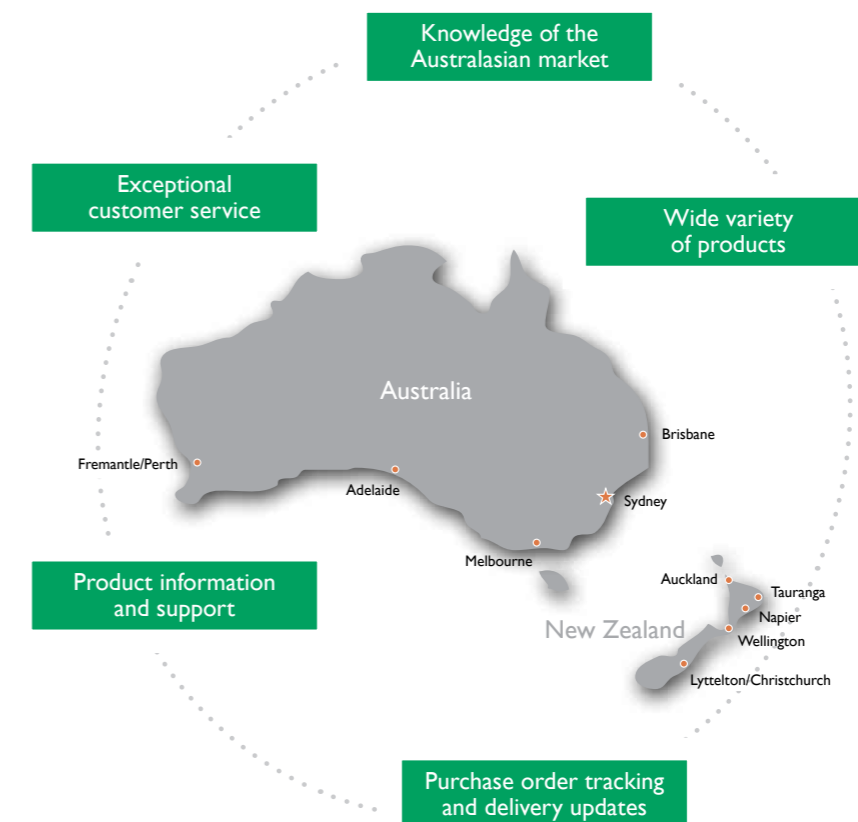

## ARAUCO in Australia and New Zealand

In 2009 ARAUCO established a sales office in Sydney to promote and sell ARAUCO's Lumber, Millwork and Panel products throughout Australia and New Zealand, servicing all main ports in the region. The new office demonstrates ARAUCO's long term commitment with our customers in the region and allows the company to have a closer understanding of their needs, aiming to enhance our service and offer the best products available in the market.

We service all main ports in the region, including Brisbane, Sydney, Melbourne, Adelaide and Fremantle/Perth in Australia, as well as Auckland, Tauranga, Napier, Wellington and Lyttelton/Christchurch in New Zealand.



## A Global Leader

For more than 45 years, ARAUCO has been driven forward by its vision of being a global leader in the development of sustainable forest products. During this time, we have evolved into one of the most respected forestry companies in the world, not only for the size and health of our plantation forests, the quality of our products and superior customer service, but for our technical innovation, environmental responsibility and social commitment as well.

ARAUCO's success is based on high quality production that satisfies our customers while balancing the company's needs with those of our employees, the environment, and the people who live near our facilities and plantations. This is the starting point for the responsible and efficient management of our natural resources, the occupational health and safety of our workers and our active contribution to social development and welfare in the communities in which we operate.

## ARAUCO's Areas

### Forests

ARAUCO sources its raw material from 1.7 million hectares (4.1 million acres) of proprietary forest lands located throughout Chile, Argentina, Brazil and Uruguay. These forest holdings, together with our sustainable management policy implemented under strict international standards, and the application of research and innovation to make full use of our fiber resource, provide the foundation for ARAUCO's continued competitive strength in the marketplace.

Through Bioforest, ARAUCO's scientific and technological research center, we apply leading-edge biotechnology to the development of new ways to increase the quality, productivity and performance of our plantations, we improve the production process of pulp and safeguard the rich biodiversity that exists within our forest holdings.

### Woodpulp

ARAUCO's wood pulp is manufactured exclusively with fiber from pine and eucalyptus forest plantations. ARAUCO's wood pulp business area produces 3.2 million ADt per year of bleached pulp, mainly used for printing and writing, and sanitary paper; unbleached pulp, used to make packaging material, fiber cement, and dielectric paper; and fluff pulp, used in the absorbent core of personal-care products.

“Making full use of our fiber resource is the key to ARAUCO's continued competitive strength in the marketplace.”

### Sawn Timber

ARAUCO's sawn timber business produces a wide variety of lumber and remanufactured wood products, with a total annual capacity of 2.8 million m<sup>3</sup> of green lumber. These products have different finishes, appearances and value-added processes, meeting the needs of the furniture, packaging, paneling, construction and remodeling industries. This business area also produces wood mouldings, edge glue boards and structural laminated beams, sold under the TruChoice brand, widely known for their consistent high quality.

### Panels

ARAUCO is well-known as one of the leading producers in the global panel market. Since the start-up of the first Plywood mill in 1997, the company has been adding new capacity and product lines, reaching today a total annual production of 6.5 million m<sup>3</sup>. The Panel products offered by ARAUCO are: AraucoPly Plywood, Trupan MDF, VESTO Particleboard and Cholguan high density Hardboard, which are widely used in the furniture, packaging, mobile homes, boat & marine industry, and the construction and renovation markets.

### Energy

ARAUCO generates its own clean, renewable electricity from forest biomass, reducing the company's greenhouse gas (GHG) emissions and its contribution to global warming. Our seven cogeneration power plants have an installed capacity of 569 MW of electric energy, enough to meet the needs of our own industrial processes and deliver 180 MW of surplus energy to Chile's Central Interconnected System.

## ARAUCO Worldwide

ARAUCO prides itself in its ability to stay ahead of changing market demands. By carefully analyzing market trends, the company is able to anticipate market needs and have the right mix of products available for its customers. Through its sales offices in Australia, China, Japan, Holland, the United States, Mexico, Argentina, Brazil,

Colombia, Peru and Chile, and sales agents in many other countries, ARAUCO delivers a superior level of customer service. This sales network, together with the company's state-of-the-art global logistics system has earned the company a reputation for consistent availability and timely delivery.



● Sales Offices  
● Operational Centers  
● Sales Agents

### Chile

1,1 million hectares of Plantation Forests  
5 Pulp mills  
8 Saw mills  
3 Panel mills  
5 Remanufacturing facilities

### USA & Canada

8 Panel mills

### Argentina

257.720 hectares of Plantation Forests  
1 Pulp mill  
1 Saw mill  
2 Panel mills  
1 Remanufacturing facility

### Brazil

173.079 hectares of Plantation Forests  
2 Panel mills

### Uruguay

132.663 hectares of Plantation Forests

### Annual Capacity

Wood Pulp  
3.2 million ADt

Sawn Timber  
2.8 million m<sup>3</sup>

Panels  
6.5 million m<sup>3</sup>

Moulding  
654 thousand m<sup>3</sup>

## Sustainability

### Environmental Responsibility

#### Sustainable Forest Management

The forests that provide wood for AraucoPly are certified as being in compliance with CERTFOR, Chile's strict national standard for sustainable forest management. Developed by a non-profit, non-governmental organization, with expert technical assistance from the Chilean Forestry Institute, the CERTFOR standard is endorsed by the International Programme for the Endorsement of Forest Certification Schemes (PEFC). CERTFOR is your assurance that AraucoPly premium panels originate in plantations that are managed in an environmentally appropriate and socially responsible manner.

In 2009 ARAUCO decided to begin the Forest Stewardship Council (FSC) forest management certification process for its forest plantations in Chile. The FSC international certification process requires strict compliance with the highest forest management standards in existence today and reflects the level of corporate responsibility required by our customers. ARAUCO maintains a firm commitment to the FSC forest management certification process, following it responsibly and transparently.

#### Protection of Native Forest

ARAUCO owns 327,000 hectares (807,000 acres) of native forest that are permanently protected under strict international regulations and management standards. These conservation set-asides include parcels that are exceptionally rich in biodiversity and have been designated as High Value Environmental Areas. In addition, ARAUCO has designated a significant portion of its forest holdings for restoration and conservation activities, environmental education programs, and scientific studies on flora, fauna, habitat and sensitive ecosystems.

#### Carbon Footprint & Carbon Sequestration

ARAUCO made a corporate commitment to not remain indifferent towards global climate change and did the Carbon Footprint Assessment (CFA) project completed in July 2009 under the guidance of AECOM Environment and Fundación Chile. The CFA project was conducted in order to benchmark the level of greenhouse gas emissions (GHG) resulting from our operations in Chile, Argentina, Uruguay, Brazil and USA.

“Environmental responsibility, the occupational health and safety of our workers, and the social development and welfare of communities in which we operate are essential to our sustainable business model”

A pioneering venture among South American companies, ARAUCO's Carbon Footprint Assessment not only identified the company's direct and indirect GHG emissions, but also those resulting from harvesting and the transportation of raw materials and finished products. The CFA also determined the amount of carbon sequestered in our forest holdings and finished products. The valuable and reliable information resulting from this study will allow ARAUCO to evaluate its progress in greenhouse gas reduction and identify opportunities for improvement.

Our forests contribute to the mitigation of global warming by naturally absorbing carbon dioxide from the atmosphere. Young trees capture GHG at a faster rate than do mature trees, this makes our forest a part of the solution in fighting global climate change. In addition, our products made from processed wood store carbon dioxide during their entire shelf life.

#### Clean Energy & Carbon Credits

At ARAUCO we know that our forest plantations present a viable solution to environmental issues as well as energy issues. Our sustainably managed forests provide recyclable, reusable and biodegradable raw material. In addition, we make full use of our fiber resource, which allows us to generate clean, renewable energy. We generate our electricity from forest biomass, reducing the company's GHG emissions.

Our ability to use forestry biomass as carbon neutral cogeneration fuel enabled ARAUCO to become in 2007 the first Chilean forestry company to issue Carbon Credits. Since then ARAUCO has issued a total of 1,070,851 Certified Emission Reduction bonds (CERs).

ARAUCO has seven biomass - based cogeneration power plants and four of them are registered under the Clean Development Mechanism of the Kyoto Protocol.

### Occupational Health and Safety of Our Workers

ARAUCO's commitment to responsible operations includes the Occupational Health and Safety (OHS) of our employees and contractors. OHS procedures for all of the company's business units are certified as compliant with the OHSAS 18001 standard. The company provides intensive training to strengthen risk-prevention management. In addition to look after the safety of all of our workers, ARAUCO is committed to creating the conditions necessary to foster career advancement and human development. ARAUCO is also committed to promoting a positive workplace based on respect, honesty, professionalism, training and teamwork.

ARAUCO has a highly successful Operational Excellence Management Program (OEMP) since 1993 to improve the personal growth, confidence and performance of workers. Based on a 7 year track record of use and success, the OEMP became the company's standard for human resources development.

### Social Development and Welfare of Communities

Our operations directly benefit 35,000 workers and their families, as well as the workers of about 1,000 contracting companies in more than 100 communities throughout Chile, Argentina, Brazil and Uruguay. In addition to the indirect economic benefits delivered by its presence in these locations, ARAUCO also stimulates economic

“ARAUCO creates the workplace conditions necessary to foster career advancement and human development”

and social development through a variety of initiatives, embracing the responsibility of improving the quality of life in the communities where we have operations. ARAUCO invested US\$12 million during 2010 in Corporate Social Responsibility programs in all the countries where it has operations.

With a firm belief of the value of education as a determining factor in personal growth and country's development, ARAUCO has made its most sizable commitment to teacher training and access to quality public education for children. The resources are channeled in support of better education through foundations in Chile (Arauco Educational Foundation and Belén Educa Foundation), Argentina (Alto Paraná Foundation) and Brazil (Arauco Brazil Environmental Education Foundation). Since 1989 Arauco Educational Foundation has increased teacher capacity through 73 programs benefiting 4,500 teachers at 530 schools and more than 81,800 students in Chile during two decades.

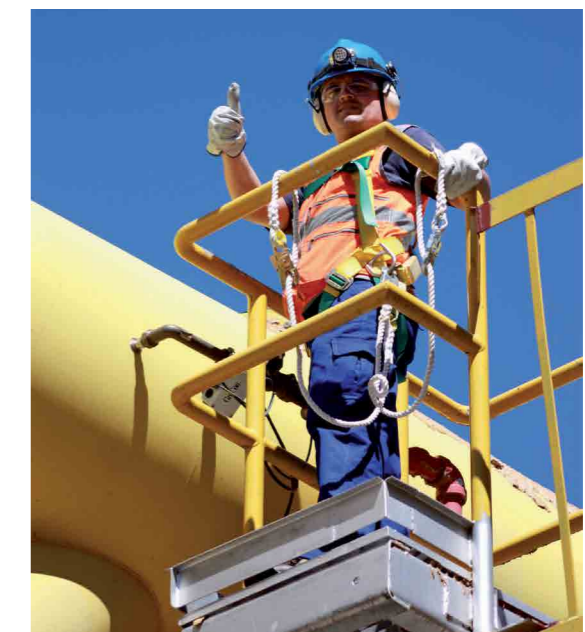

# Plywood Products

## Certifications

### AS/NZS 2269

AraucoPly has been manufactured and tested to meet all requirements of Plywood Structural Standard AS/NZS 2269 in products that are stamped and labelled accordingly, as per the following licenses granted by SAI Global:

- Horcones Arauco Mill :Licence N° SMKB21663/1
- Ranquil Nueva Aldea Mill :Licence N° SMKB21663

### PS 1-09

All grade stamped AraucoPly panels are manufactured according to criteria established in the US PS 1-09 standard. AraucoPly qualifies for TECO grade stamping under voluntary product standard PS 1-09 for grades AA through CD, including structural applications.

### CE EN 13986

AraucoPly complies with CE 2+ EN 13986:2004 for structural use, which is the European certification for wood-based panels under the European CPD (Construction Products Directive).The certification was originally obtained in 2003. Our plywood is certified through the Danish Technological Institute, under numbers 1073-CPD-801 and 1073-CPD-809.

### JAS

Japan Plywood Inspection Corporation approved AraucoPly for use in JAS certified load-bearing construction applications. This certification was issued under the law concerning the Standardization and Proper Labeling of Agricultural and Forestry Products.

### PEFC

The plantation forests that supply wood for AraucoPly products are certified as compliant with the CERTFOR sustainable forest management standard. CERTFOR is endorsed by PEFC (Programme for the Endorsement of Forest Certification Schemes).With some 187 million hectares under certification, PEFC is the world's largest forest certification program.



PS1-09 UL

For more information about ARAUCO's certifications please see FAQ n°3 (Page 25), or visit our website [www.arauco.cl](http://www.arauco.cl).

## Product Range

ARAUCO has a comprehensive range of Plywood grades, finishes and sizes for various applications, some of them tested to meet the structural Australian and New Zealand standards. The products specifically offered for this market are:

- CD & DD Structural
- Structural Flooring and Roofing
- Cladding
- Appearance & Lining Grade
- Non-Structural

Plywood grade is defined by the veneer grade used in the face and the back of the panel. In descending order of quality the veneer grades are A, B, C, D. For example; a panel CD means that the face is C grade and the back is D. The face is always sanded smoother than the back face.

Table 1: ARAUCOPLY GRADING SUMMARY

		CD Structural	DD Structural	Flooring	Roofing	Cladding	Grooved Lining	Appearance	Non-Structural
Species	100% Radiata Pine	•	•	•	•	•	•	•	•
Certifications	PEFC	•	•	•	•	•	•	•	•
	AS/NZS 2269	•	•	•	•	•			
	US PS1-09						•	•	•
	CE-EN 13986						•	•	•
F-Rating	Parallel F11			•	•				
	Parallel F8	•	•	•	•	•			
Surface	Face Sanding 150 grit	•		•			•	•	
	Face Sanding 100 grit		•		•				•
	Bandsawn					•			
	Thickness Calibration	•	•	•	•	•	•	•	•
Bonding	WBP A-Bond Resin	•	•	•	•	•	•	•	•
	Guaranteed Glueline	•	•	•	•	•	•	•	•
	Ultrasound Tested for Blows	•	•	•	•	•	•	•	•
Emission	AS/NZS 2098.11 Super E <sub>0</sub>	•	•	•	•	•	•	•	•
	JIS Super E <sub>0</sub> LFE	•	•	•	•	•	•	•	•
Repairs	Filler / Putty	•	•	•	•	•	•	•	•
	Wooden Boat Patch	•	•	•	•	•			•
Acceptable Defects	Synthetic Patch	•	•	•	•				•
	Minor Open Defects	•	•	•	•	•	•	•	•
	Tight Knots Up to 10mm					•	•	•	
	Tight Knots Up to 25mm	•		•					
	Tight Knots Up to 50mm		•		•				•

Notes: Grading above refers to Face veneers. / LFE: Low Formaldehyde Emission.



## CD Structural

AraucoPly CD Certified Structural is a grade primarily for use in visual applications where the end use is to be seen. Certified to AS/NZS 2269 it gives you the assurance that it also has structural integrity, tested to the harsh New Zealand and Australian conditions.

The product is identified with a blue stripe down the middle of the short edges of the panel.

The AraucoPly CD is a superior grade with no open face knotholes and no more than 8 wood patches with limited synthetic repairs on the face. A reasonably clean face veneer with any defects filled and finished with 150 grit sanding on the face veneer and 100 on the back veneer. The perfect grade for use in the following applications:

- Concrete formwork to a F3 Standard NZS 3114-1987.
- Under roof decking, soffit linings, wall linings, ceiling linings.
- Plywood box beams or signage.
- General industrial applications, furniture, bracing, flooring, mobile homes, boat industry fittings.

**Note:** Although a CD Grade finish is an acceptable solution in the New Zealand and Australian Building code for the exterior cladding of housing, ARAUCO recommends the use of AraucoPly Cladding, protected accordingly to avoid surface bubbling and face checking, that can occur under extreme weather conditions.

See technical information in *Table 1: AraucoPly Grading Summary (Page 9)*.

## DD Structural

AraucoPly DD Certified Structural is a grade primarily for use in non-visual applications where the end use is not intended to be seen. Certified to AS/NZS 2269 the DD grade also gives you the assurance of structural integrity. With more face veneer imperfections than CD Structural, it is primarily for structural construction where it is in behind the finished product such as a bracing element in housing.

The AraucoPly DD has a solid face with tight knots, limited wood patches and synthetic repairs. The product is identified with a green stripe down the middle of the short edge of the panel. Finished on the face with at least a 100 grit sanding and 80 grit on the back veneer AraucoPly DD grade is the perfect grade for use in the following applications:

- Hoardings around construction sites.
- Bracing elements in housing or commercial construction.
- Wall lining where you want a bit more knotty character than the CD Grade.
- Lining a shed or building a dog house.
- Plywood box beams, building crates or pallets.
- General industrial applications.
- Linings factory walls.

See technical information in *Table 1: AraucoPly Grading Summary (Page 9)*.



## Structural Flooring

AraucoPly Flooring Grade Structural is a product that is designed for use as a flooring substrate as well as an ideal substrate under roofing or decking rubber membranes. Certified to AS/NZS 2269 to a strength grade of F11 gives you the assurance of the structural integrity along with the knowledge that this is a product designed for use in New Zealand and Australia.

A plastic tongue and groove down the length of the board makes for easy joining of the product over joists and means that no support is needed on these joints unless otherwise specified by the engineer where roof diaphragm bracing or significant point loading is a consideration. AraucoPly Flooring shall always be laid perpendicular to the joists to ensure the maximum strength of the product is maintained.

Figure 1: ARAUCO FLOORING LAYOUT

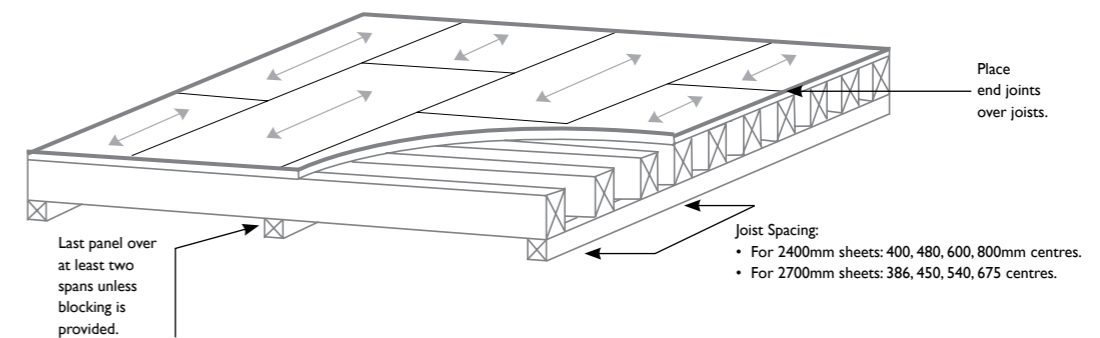

For Span Tables please see technical information in *Table 8: Flooring and Decking Strength / Stiffness Rating (Page 19)*. For *Fixings and Adhesives* see Page 22.

It is important to note that when using AraucoPly Flooring that has been treated you must seal any cut edges with a brush on remedial treatment. A product such Metalex Green End Seal end seal is ideal for this purpose.

**Ideal applications include:** Residential or commercial flooring, flooring in wet areas, such as bathrooms toilets or kitchens, for use under rubber membranes to provide the best substrate, decks, roofing, wall linings, general industrial applications, and flooring for mezzanine floors.

## Structural Roofing

AraucoPly Roofing Grade Structural is a product that is designed for use as a roofing substrate primarily for use under shingles. Certified to AS/NZS 2269 to a strength grade of F11 gives you the assurance of the structural integrity along with the knowledge that this is a product designed specifically for use in New Zealand and Australia.

This product has a plastic tongue and groove down the long edge of the sheet to allow for easy joining of the product over roof trusses. Sheets shall always be laid perpendicular to the roof truss to ensure that the maximum strength of the product is maintained. If treated AraucoPly Roof is installed after it has been cut, it is vital that the cut edge be sealed with a remedial preservative treatment such as Metalex Green End Seal. This also applies to any penetrations in the middle of the sheet such as pipes, vents or skylights.

When fixing the sheets to the roof ensure that you stagger the joints of the sheets. 50mm ring shank or annular grooved 2.8mm nails at 150mm centres should be used when fixing the sheets and stainless steel fixings are recommended for any coastal areas. Around the edge of the roof, at gable ends, eaves or gutters, the sheets must be properly supported and fixings should be at 100mm centres. In high wind zones it is recommended that stainless steel screws are used.

For Span Tables please see technical information in *Table 9: Roofing Strength / Stiffness Rating (Page 20)*.

## Cladding

AraucoPly Cladding Structural is a product that is designed for use as the exterior cladding of your house, commercial premises, shed or barn. Certified to AS/NZS 2269 gives you the assurance of the structural integrity of AraucoPly Cladding knowing that it is a product designed specifically for the New Zealand and Australian conditions. AraucoPly Cladding has also been tested to the P21 Bracing test and when installed correctly will form part of the bracing requirements for your project. See *chapter Bracing Ratings* (Page 21) for more details. AraucoPly Cladding may be direct fixed to the stud or installed over 20mm battens to form a cavity. AraucoPly Cladding must overhang the bottom plate or concrete slab by 50mm as required by NZS3604.

AraucoPly Cladding should always be treated to H3.1 using the Light Organic Solvent Preservative (LOSP).

AraucoPly Cladding comes in 2 different varieties of Face finishing, always with a band sawn face veneer:

- **AraucoPly Cladding Texture:** This product has a Bandsawn face veneer with a shiplap joining system down the long edge of each sheet. The overall finish once sealed and painted will give you a clean modern finish for your project. AraucoPly Cladding Texture is also the ideal product to use when you are trying to achieve the board and batten finish.
- **AraucoPly Cladding Deep Groove:** The AraucoPly Cladding Deep Groove product has a bandsawn face, the shiplap joining system as above along with a deep groove on 150mm centres. Grooves are 9mm wide and 6mm deep which give you a traditional plywood cladding look for your project.

Figure 2: ARAUCOPLY CLADDING 12mm DEEP GROOVE PROFILE

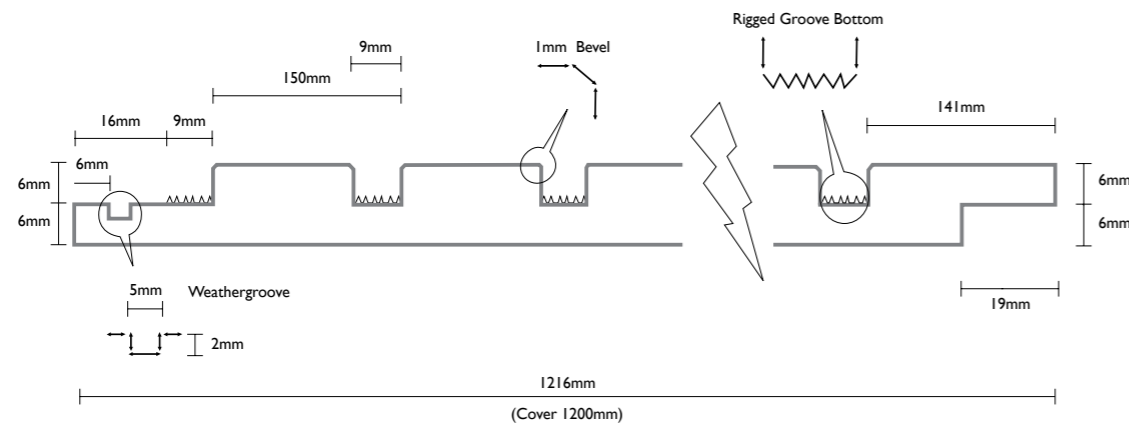

AraucoPly Cladding also gives you other benefits that come with AraucoPly manufacturing such as Super-E<sub>0</sub> low formaldehyde emission, WBP A-Bond glue line, thickness calibration, certified strength and integrity with every sheet being ultra sounded for blows prior to delivery from the plant, the knowledge that all the product is produced from PEFC certified sustainable Radiata Pine plantations and much more.

Some important notes when fixing AraucoPly Cladding products:

- It is recommended that you always use stainless steel or silicon bronze fasteners.
- Always use extruded aluminium flashings that have been tested by BRANZ for weather tightness.
- Never nail inside the groove with either the deep groove or shallow groove panels.
- AraucoPly Cladding must always be installed vertically in an exterior situation.
- As soon as possible and preferably before any exposure to weather AraucoPly Cladding must be sealed and protected with at least 2 coats of premium exterior acrylic paint.
- AraucoPly Cladding must be properly maintained on a regular on-going basis. It must be kept clean and the paint must be maintained in accordance with the paint manufacturers specifications.

### Additional Cladding Recommendations

#### Edge Sealing

All plywood panels experience faster moisture penetration through panel ends and edges. As a result, edges and ends should be sealed. Edge sealers help to minimize sudden changes in panel moisture content due to normal climatic changes after installation.

#### Surface Preparation

Panel surfaces should be free from dirt and loose wood fibres. All finishes should be applied as soon as possible after panel installation. Apply finishes during favourable weather conditions and always follow the finish manufacturer's specific application recommendations for plywood products. Use only first quality finishes and apply according to the application rates recommended by the finish manufacturer.

Rough or band sawn surfaces may require up to twice as much finish as smooth or scratch sawn surfaces. The initial coat should be applied by brush. Sprayed on finishes should be either back brushed or back rolled while wet. Additional coats may be applied conventionally.

#### Recommended Finishes

**Solid Colour Stains:** Two coats of a high quality oil base or latex opaque stain help mask colour variations between wood repairs and the surrounding wood. Face grain is also masked with opaque stains but allows rough sawn textures to remain visible. It is also recommended that the desired finish be applied to a representative panel sample which contains typical colour variations and repairs to ensure that the panel's finished appearance is acceptable.

**Acrylic Latex Paint:** If a painted finish is desired, an acrylic latex paint system composed of at least one stain resistant primer coat and topcoat is recommended for textured cladding. Acrylic latex produces a durable finish that masks textured surfaces more than an opaque stain and can obscure grain and colour differences. Again it is imperative to follow the paint manufacturer's recommendations for plywood cladding application.

The use of dark colours is not recommended. The use of colours with a minimum Light Reflectance Value (LRV) of 40% will extend the life of the Plywood and coating.



## Appearance & Lining Grades

The Appearance category of AraucoPly panels is not tested to the AS/NZS 2269 Standard. All good, they are certified according to international standards such as the European CE-EN 13986, US PSI-09 or Japanese JAS, manufactured by ARAUCO under strict quality control, and offers all the benefits of AraucoPly, such as Super-E<sub>0</sub> low formaldehyde emission, WBPA-Bond glue line, thickness calibration and full 150 grit sanding, strength and produced from PEFC certified sustainable Radiata Pine plantations.

The Appearance product category uses a high grade solid and fully sanded face (An grade). The product is offered with 3 different surface patterns:

- AnC No-Groove (1 good side).
- AnAn No-Groove (2 good sides).
- AnCV-Groove 100mm on centre.

Figure 3: V-GROOVE PROFILE 100mm ON CENTRE

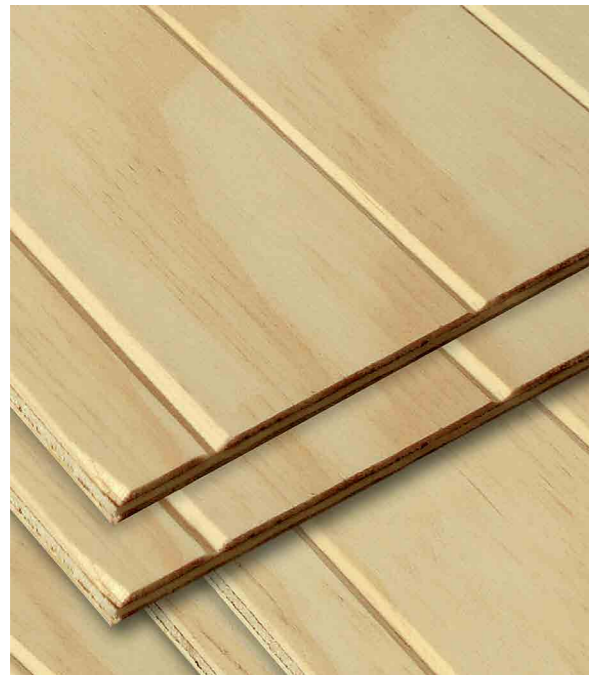
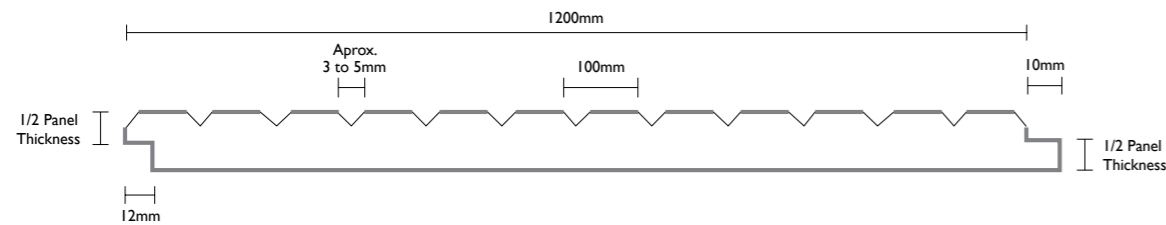

It is an excellent choice for any application that requires a higher quality finish. Ideal applications include:

- Wall and ceiling lining.
- Furniture.
- Cabinets.
- Decorative panels.
- Substrate for high pressure laminate.
- Pool tables.
- Speakers.
- Countertops.
- Lining your sport facilities such as gyms or school halls.
- Lining convention centres.
- Soffit lining.
- General Do It Yourself (DIY) uses.

See technical information in *Table 1: AraucoPly Grading Summary* (Page 9).

Please contact your AraucoPly distributor for more information in regards the product range available.

## Non-Structural

The “Non-Structural” category of AraucoPly panels is not tested to the AS/NZS 2269 Standard. However, all panels are certified according to international standards such as the European CE-EN 13986, US PSI-09 or Japanese JAS, manufactured by ARAUCO under strict quality control. The Non-Structural category also offers all the benefits of AraucoPly, such as Super E<sub>0</sub> low formaldehyde emission, WBPA-Bond glue line, thickness calibration, strength, stiffness and stability characteristics and produced from PEFC certified sustainable Radiata Pine plantations.

The Non-Structural product category includes a wide range of grades, from appearance to lower end packaging grade. Typical applications are:

- Wall hoardings.
- Sand pits.
- Shelving.
- Building the dog house or kids playhouses.
- Landscaping fencing.
- Formwork for paths and driveways.
- Motorway sidings.
- Making furniture or toys.
- Temporary weatherproofing for damaged buildings.

Please contact your AraucoPly distributor for more information in regards to the product range available.





## Technical Information

### Species

All AraucoPly is produced using 100% Radiata Pine veneers from our own sustainable plantations resources managed in Chile. For further information about sustainable practices of ARAUCO please refer to *chapter Sustainability* (Page 6).

### Moisture Content

AraucoPly has an average moisture content between 9 and 10% when manufactured. It should be protected from wet conditions throughout delivery, storage on site, and in construction applications such as roofs, walls and floors. For more information refer to *Storage and Handling* (Page 22).

### Adhesives & Emissions

AraucoPly is certified A-Bond using an Exterior Phenol-Formaldehyde resin, emission class Super E<sub>0</sub> in accordance with Standard AS/NZS 2098.11 - "Determination of Formaldehyde Emissions". AraucoPly also complies with other international Low Formaldehyde Emission (LFE) requirements like Japanese Standard JAS Super-E<sub>0</sub> or F★★★★.

While the Formaldehyde Emission limit in AS/NZS 2269.0:2012 is max 0.40 mg/L for Super E<sub>0</sub>, AraucoPly's emission is typically below 0.03 mg/L.

Table 2: EMISSION TABLE

Emission Class / Product		Formaldehyde Emission	
		mg/L	ppm
AraucoPly	Typical Emission	0.03 avg	-
AS/NZS 2269.0:2012	Super E <sub>0</sub>	0.30 avg, 0.40 max.	0.024 avg, abt 0.032 max.
	E <sub>0</sub>	0.50 max.	abt 0.041 max.
	E <sub>1</sub>	1.00 max.	abt 0.080 max.
JIS A1460	Super E <sub>0</sub>	0.30 max.	-
	E <sub>0</sub>	0.50 max.	-
	E <sub>1</sub>	1.50 max.	-
CARB (USA)	Phase 2 (MDF)	-	0.110 max.
	Phase 1 (MDF)	-	0.210 max.
Natural Emission	Oak Tree	-	0.009
	Shell Fish	-	0.100
	Pork	-	0.020

### Glue Bond

AraucoPly not only meets or exceeds the quality expected in the marketplace, but also offers a glue bonding warranty for products purchased in Australia or New Zealand.

ARAUCO warrants that AraucoPly products will not delaminate for 25 years from the date of purchase by the structure's original builder or original owner. This warranty is in effect as long as AraucoPly panels have been properly installed and finished in accordance with published installation instructions from ARAUCO and recommendations of the Australian and New Zealand Building Code.

For more information and limitations about this warranty visit our web page [www.araucopy.com/oc](http://www.araucopy.com/oc).

## Dimensional Properties

### Tolerances:

- Length : +1.5mm/-1.5mm on the specified nominal value.
- Width : +1.5mm/-1.5mm on the specified nominal value.
- Thickness : ±0,4mm on the specified nominal value for sanded grades.
- Squareness : Within 0.2% of the length of the longer diagonal.
- Straightness: Within 0.05% of the length.
- Diagonals : Below 3mm difference on a 2400x1200mm sheet.

Table 3: LAY-UP PROPERTIES AND WEIGHTS

Nonimal Thickness mm	Number of Plies N°	Face Thickness (nominal) mm	AVG Mass per Sheet kg
6.5	3	2.54	10.1
7	3	2.54	10.9
9	3	3.15	14.0
12	5	2.54	18.7
15	5	3.15	23.3
18	7	2.54	28.0
19	7	3.15	29.5
21	7	3.15	32.7
25	9	3.15	38.9
30	11	2.54	46.7

Mass has been calculated considering 9 to 10% moisture content and sheet size of 2400x1200 and a density of 540 kg/m<sup>3</sup>.

## Structural Properties

Table 4: F-GRADE VALUES PER AS / NZS 2269.0:2012

		Strength (MPa)		Stiffness (MPa)		Tensile (MPa)		Shear (MPa)		Compression in plane (MPa)	
		//	⊥	//	⊥	//	⊥	//	⊥	//	⊥
Square Edge F8	CD, DD	25	25	9,100	9,100	15	15	4.2	4.2	20	20
Flooring F11	CD T&G	31	-	10,500	-	-	-	-	-	-	-
Roofing F11	DD T&G	31	-	10,500	-	-	-	-	-	-	-

In accordance to AS/NZS 2269 AraucoPly Flooring and Roofing are rated F11, considering its outstanding performance in parallel bending and stiffness strength.

In 2014, Arauco expects to release F14 grade Flooring and Roofing with the start up of its new Nueva Aldea Mill.

Table 5: SECTION PROPERTIES OF ARAUCOPLY STRUCTURAL PLYWOOD

Nominal Thickness	ID Code	Mass	Section Properties per mm Width							
			Parallel to Face Grain				Perpendicular to Face Grain			
			Moment of Inertia, I	Section Modulus, z	Shear Constant I/Q	Section Area, A	Moment of Inertia, I	Section Modulus, z	Shear Constant I/Q	Section Area, A
mm		kg/m <sup>2</sup>	mm <sup>4</sup>	mm <sup>3</sup>	mm <sup>2</sup>	mm <sup>2</sup>	mm <sup>4</sup>	mm <sup>3</sup>	mm <sup>2</sup>	mm <sup>2</sup>
6.5	6.5-24-3	3.9	29.5	8.2	5.16	4.8	2.0	0.95	2.28	2.5
7	7-24-3	3.9	29.5	8.2	5.16	4.8	2.0	0.95	2.28	2.5
9	9-30-3	4.9	56.3	12.7	6.40	6.0	3.9	1.46	2.83	3.1
12	12-24-5	6.6	113	18.8	9.21	7.3	32.9	8.2	5.40	5.0
15	15-30-5	8.1	216	28.9	11.4	9.1	62.7	12.7	6.70	6.2
18	18-24-7	9.8	339	37.5	12.6	10.9	150	21.4	10.5	7.5
19	19-30-7	10.5	436	45.5	13.6	12.1	153	21.4	10.6	7.5
21	21-30-7	11.4	534	50.9	15.0	12.1	230	28.9	11.7	9.2
25	25-30-9	13.4	868	70.4	17.6	15.1	372	37.5	13.2	10.0

Table 6: NOMINAL STRENGTHS OF ARAUCOPLY SQUARE EDGE & T&G F8 PLYWOOD

Nominal Thickness	ID Code	Weight	Nominal Strengths (Limit State) per mm Width							
			Parallel to Face Grain				Perpendicular to Face Grain			
			Bending Stiffness, EI	Bending Moment, fz	Rolling Shear fl/Q	Axial Compression, fQA	Bending Stiffness, EI	Bending Moment, fz	Rolling Shear fl/Q	Axial Compression, fQA
mm		Pa	kNmm <sup>2</sup>	Nmm	N	N	kNmm <sup>2</sup>	Nmm	N	N
6.5	6.5-24-3	37	269	206	9.8	97	18.4	23.8	4.3	50.6
7	7-24-3	37	269	206	9.8	97	18.4	23.8	4.3	50.6
9	9-30-3	46	512	317	12.2	120	35.0	36.5	5.4	62.8
12	12-24-5	62	1,030	470	17.5	146	299	206	10.3	100
15	15-30-5	77	1,964	723	21.7	181	570	317	12.7	124
18	18-24-7	93	3,084	937	24.0	218	1,365	535	20.0	150
19	19-30-7	99	3,971	1,137	25.8	241	1,392	535	20.1	150
21	21-30-7	108	4,862	1,273	28.5	242	2,093	723	22.2	185
25	25-30-9	127	7,901	1,761	33.4	302	3,383	939	25.2	200

Table 7: NOMINAL STRENGTHS OF ARAUCOPLY T&G F11 FLOORING & ROOFING PLYWOOD

Nominal Thickness	ID Code	Weight	Nominal Strengths (Limit State) per mm Width							
			Parallel to Face Grain				Perpendicular to Face Grain			
			Bending Stiffness, EI	Bending Moment, fz	Rolling Shear fl/Q	Axial Compression, fQA	Bending Stiffness, EI	Bending Moment, fz	Rolling Shear fl/Q	Axial Compression, fQA
mm		Pa	kNmm <sup>2</sup>	Nmm	N	N	kNmm <sup>2</sup>	Nmm	N	N
15	15-30-5	77	2,575	1,157	24.9	272	647	317	13.8	124
18	18-24-7	93	4,029	1,499	27.4	327	1,487	535	21.4	150
19	19-30-7	99	5,199	1,819	29.5	362	1,548	535	21.9	150
21	21-30-7	108	6,353	2,037	32.3	363	2,283	723	23.8	185

**Note:**

- Material properties calculated in accordance with AS/NZS 2269.
- Properties and Strengths for other layups are available on request.

## Span Ratings Flooring

Maximum recommended frame centres for AraucoPly (mm).

Table 8: FLOORING AND DECKING STRENGTH / STIFFNESS RATING

Flooring Application (UDL / Conc live load)	Length	F grade	Maximum spacing of support framing (mm) Plywood thickness				
			15	18	19	21	25
Domestic Flooring 2.0 kPa / 1.8 kN	2,400	F8	400	480	600	600	800
		F11	480	600			-
		F14			386	540	675
	2,700	F8	450	540	675	675	-
		F11	450	540	675	675	-
		F14					-
Domestic Garage 2.5 kPa / 9.0 kN	2,400	F8	-	-	-	343	480
		F11	-	-	-	400	-
		F14					-
	2,700	F8	-	-	-	386	450
		F11	-	-	-	386	-
		F14					-
Office 3.0 kPa / 2.7 kN	2,400	F8	-	400	480	600	800
		F11	-	480	600	800	-
		F14					-
	2,700	F8	-	386	540	540	675
		F11	-	450	540	675	-
		F14					-
Retail 4.0 kPa / 3.6 kN	2,400	F8	-	-	-	400	600
		F11	-	400	480	600	-
		F14					-
	2,700	F8	-	-	-	386	675
		F11	-	386	450	540	-
		F14					-
Industrial 5.0 kPa / 4.5 kN	2,400	F8	-	-	-	-	480
		F11	-	-	-	343	-
		F14					-
	2,700	F8	-	-	-	-	540
		F11	-	-	-	386	-
		F14					-

**Tests Notes:**

- Design actions as defined in AS/NZS 1170. Refer to code for clarification of application, and for a more extensive list.
- Tables designed for IL2 buildings, 50 year working life. Specific design recommended for other applications.
- Support framing width assumed to be 45mm.
- Ply face grain perpendicular to support framing.
- Staggered joints, minimum two spans per sheet.
- Flooring applications designed for a 1.5mm deflection under a 1.0 kN point load. This is in the middle of the AS/NZS 1170 suggested range - for more sensitive applications, specific design is recommended.
- Concentrated loads are applied over varying footprints, as defined in AS/NZS 1170.
- Flooring tables assume a floor dead load of 0.4 kPa.

## Span Ratings Roofing

Maximum recommended frame centres for AraucoPly (mm)

Table 10: ROOFING STRENGTH / STIFFNESS RATING						
Roofing Application (UDL / Conc live load)	Length	F grade	Maximum spacing of support framing (mm) Plywood thickness			
			15	18	19	21
Sub-Sheating n.a. kPa & n.a. kN	2,400	F8	1,200	1,200	1,200	1,200
		F11				
		F14				
	2,700	F8	1,350	1,350	1,350	1,350
		F11				
		F14				
Non-Trafficable (45 deg) 0.25 kPa / 1.1 kN	2,400	F8	800	800	800	1,200
		F11			1,200	
		F14				
	2,700	F8	900	900	900	900
		F11			1,350	
		F14				
Non-Trafficable (30 deg) 0.25 kPa / 1.1 kN	2,400	F8	600	800	800	800
		F11	800			
		F14				
	2,700	F8	675	675	900	900
		F11	900			
		F14				
Non-Trafficable (less than 10 deg) 0.25 kPa / 1.8 kN	2,400	F8	600	800	800	800
		F11				
		F14				
	2,700	F8	540	675	900	900
		F11	900			
		F14	675			

### Tests Notes:

- Design actions as defined in AS/NZS 1170. Refer to code for clarification of application, and for a more extensive list.
- Tables designed for IL2 buildings, 50 year working life. Specific design recommended for other applications.
- Support framing width assumed to be 45mm.
- Ply face grain perpendicular to support framing.
- Staggered joints, minimum two spans per sheet.
- Roofing tables assume design action from:
  - Snow Ground snow load  $S_g = 3.75$  kPa (sub-alpine to 900m).
  - Wind  $W_u = 5.80$  kPa,  $W_s = 3.93$  kPa (winds to Extra High (55m/s),  $C_p(in) = 1.05$ ,  $C_p(out) = 1.6$ ,  $K_1 = 2.0$ ).
  - Dead load light roof = 0.2 kPa, heavy roof = 0.6 kPa.

## Bracing Ratings

In accordance to AS/NZS 2269, our Structural Square-edge and Bracing is rated F8 which includes testing for parallel and perpendicular bending, stiffness, tensile, shear and compression strength. The following table shows bracing ratings according to P21 racking test.

Table 10: BRACING RATINGS FOR ARAUCOPLY CERTIFIED STRUCTURAL PLY AND CLADDING PRODUCTS							
Arauco Code	Min Wall Length	Plywood Thickness	Max Stud Spacing	Wind*		Earthquake**	
	mm	mm	mm	BU/m	kN	BU/m	kN
API	1,200	6.5	600	130	6.5	132	6.6
AP2	1,200	7.0	600	142	7.1	144	7.2
AP3	1,200	12 Grooved	600	123	6.2	132	6.6

**Notes:** 20 bracing units = 1 kN.

\* As limited by the serviceability load capacity.

\*\* As limited by the ultimate load capacity.

Figure 4: BRACING TEST

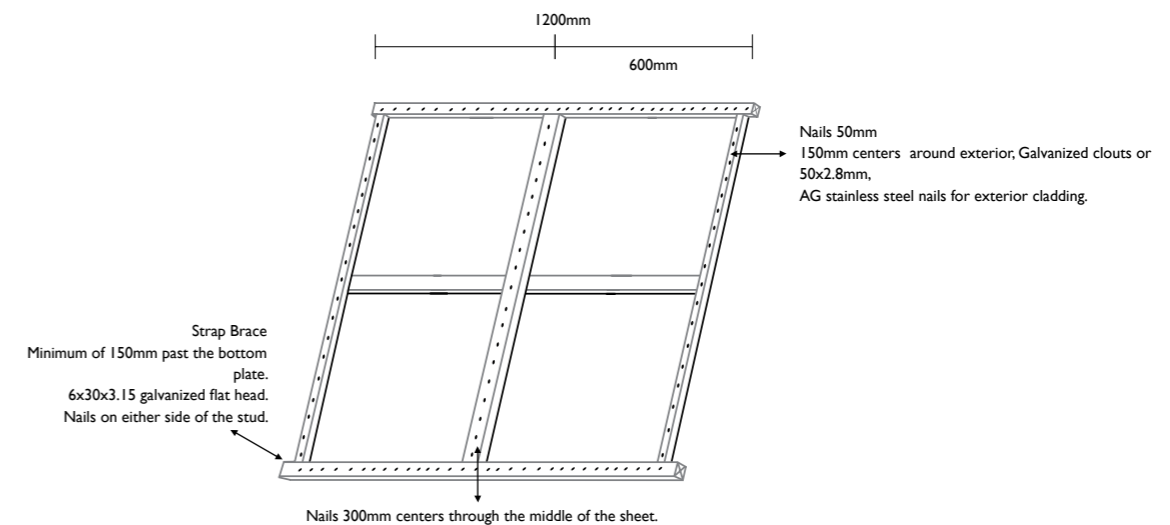

### Test Notes:

- Walls were constructed using 90x45 MSG8 studs (600 centres), plates and noggs.
- For 6.5mm and 7mm the plywood was fixed with 50x2.8 galvanized clouts at 150mm centres around the perimeter and at 300mm centres in the middle.
- For the 12mm Plywood 50x2.8mm Annular Grooved Stainless steel fixings were used at the same centres as above.
- Straps of 25x0.9mm around the bottom plate at each outside stud and extended a minimum of 150mm past the top of the bottom plate were used with at least 6 timber bracket galvanized 30x3.15mm FH nails on each side of the plate giving 6kN on each side of the stud.
- Tested on a concrete floor with 2 M12 hold down bolts and 50x50x3 galvanized washers on each.
- Tested by Scion, New Zealand April 2011.



## Thermal Conductivity

AraucoPly has an average thermal conductivity of 0.13 W/mK. The following table shows the specific conductivity for each thickness.

Thickness mm	Conductivity W/mK
9	0.112
12	0.138
15	0.134
18	0.158

## Fire Tests on Building Materials

AraucoPly has been tested for ignitability, flame propagation, heat release and smoke release in accordance to AS/NZS 1530.3:1999.

Tested with a clean faced AraucoPly by CSIRO Materials Science and Engineering, Australia, February 2013.

Regulatory Indexes	Result	Range
Ignitability Index	13	0 - 20
Spread of Flame Index	8	0 - 10
Heat Evolved Index	7	0 - 10
Smoke Developed Index	3	0 - 10

Additionally, AraucoPly 9 to 18mm has been tested at 50-kW/m<sup>2</sup> irradiance in accordance with AS/NZS 3837:1998 and classified as Group Number 3 in accordance with Specification A2.4 of the Building Code of Australia, with an average specific extinction area of 69.4 m<sup>2</sup>/kg.

Tested with a clean faced AraucoPly by CSIRO Materials Science and Engineering, Australia, January 2012.

## Fixings and Adhesives

All fasteners used must be corrosion resistant to the appropriate specification level depending on the end use; a life expectancy of 15 to 50 years should be considered.

When fixing AraucoPly Flooring it is important that you use glue and screws to minimize the potential chance of squeaking. Mechanical fixings must be either annular grooved stainless steel nails 50mm long or stainless steel screws at least 50mm in length. Fixings should be at 150mm centres at all points of contact with the framing.

Always allow an expansion gap when installing AraucoPly Flooring. This gap will depend on the size of the floor but at least a 3mm gap is suitable for most applications.

## Product Identification

In accordance with AS/NZS 2269, every sheet of AraucoPly has the following information marked on the back:

- Company name: PANELES ARAUCO S.A.
- Mill: e.g. PLANTA TERCIADO ARAUCO.
- Country: CHILE.
- License: e.g. Lic. SMKB 21663/1.
- Certification body: SAI GLOBAL.
- Intended application: e.g. STRUCTURAL, FLOORING OR ROOFING.
- Australian Standard: AS/NZS 2269:2012.
- Face grade, back grade: e.g. CD or DD.
- Glue bond & formaldehyde emission class: A BOND - Super E<sub>0</sub>
- Stress grade parallel/perpendicular: e.g. F8/- or F11//
- Panel construction code: e.g. 12-24-5 (thickness (mm)-face veneer thickness (mm x 10)-number of veneers).

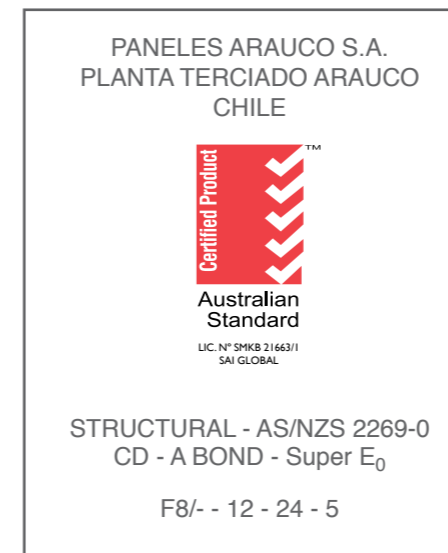

## Storage and Handling

AraucoPly should be handled and stored with care. In order for you to get the finish and end result that you are looking for:

- The product should be stored until used in a dry area protected from the sun, rain, wind or snow.
- The product should not be placed directly on the ground unless inside and should be supported with at least 3 but preferably 4 supports.
- AraucoPly should always be stored flat and not on the edge. This is a dangerous practice and could cause injury if they were to fall.
- Careful handling and proper storage will prolong the usability of the panel. Dropping panels is one of the most common ends to an otherwise good panel.
- If possible store in the room for at least 24 hours prior to installation when using AraucoPly inside. This will give it time to reach equilibrium moisture content and reduce the potential for movement after installation.

For further information about storage and handling recommendations, please refer to standard AS/NZS 2269.

Additionally, a material safety data sheet is available in our website [www.araucopy.com/oc](http://www.araucopy.com/oc).

## FAQ

### 1. What differentiates AraucoPly from other imported products?

Arauco is the main producer of Plywood in Latin America and also one of the largest in the world. AraucoPly has an integrated business model having a focus on a consistent quality product from the nursery to planting, maintenance of the forest to harvesting, production or manufacturing to sales offices all around the world to ensure that the AraucoPly brand means quality.

A constant focus on the latest technologies being utilized to their maximum potential with on-going innovation and product development means that AraucoPly will offer a great quality of Plywood for many years to come.

### 2. What are ARAUCO's sustainable practices?

- 100% of wood from certified, sustainably managed plantation forests.
- Certified to strict CERTFOR forest management standards that are endorsed by international non-profit group PEFC.
- Verified legal origin.
- No use of native forests.
- No genetically modified trees.
- Mills powered by biomass-generated green power.
- Responsible operations including the Occupational Health and Safety (OHS) of our employees and contractors.
- Commitment to create the conditions necessary to foster career advancement and human development of our workers.
- Commitment to make quality public education available in the communities near our operations according to our vision of education as the foundation for a country's development.

### 3. What certifications does ARAUCO have?

All of ARAUCO's production units operate under certified environmental management systems that also ensure the traceability of the raw materials we use.

ARAUCO's forest plantations and production facilities are certified to widely-accepted international standards, providing customers with third-party assurance of responsible operations. These certification standards include:

- ISO 9001 Quality Management System.
- ISO 14001 Environmental Management System.
- CERTFOR/PEFC Sustainable Forestry Management and Chain of Custody (in Chile).
- FSC and CERTFOR/PEFC Sustainable Forestry Management and Chain of Custody (in Brazil).
- OHSAS 18001 standard, Occupational Health and Safety (OHS) of our employees and contractors, for all of the company's business.
- Plywood Structural Standard AS/NZS 2269 in products that are stamped and labelled.
- USDA's Lacey Act Compliant, regulation governing the importation of plant-based products that verifies legal origin (AraucoPly premium panels).
- TECO. All plywood is continuously tested by mill based, certified technicians. All grade-stamped products are tested on an ongoing basis to ensure compliance with PS 1-09 manufacturing standards.
- CE EN 13986. AraucoPly complies with CE 2+ EN 13986:2004 for structural use, which is the European certification for wood-based panels under the European CPD (Construction Products Directive).
- JAS. Japan Plywood Inspection Corporation approved AraucoPly for use in JAS certified load-bearing construction applications. This certification was issued under the law concerning the standardization and proper labeling of agricultural and forestry products.
- DIN 68705, certification under the German Industrial Norm for the use of adhesives.
- AS/NZS 2269 for Plywood in Australia and New Zealand.
- British Board of Agreement BBA certification, for structural uses.
- P30 Swedish Standard SBN 1975.5, for structural uses.

### 4. What type of glue is used to manufacture ARAUCO products?

All AraucoPly is glued with WBP A-bond Exterior Phenol-Formaldehyde resin.

### 5. Is AraucoPly a LFE panel?

AraucoPly is a Low Formaldehyde Emission (LFE) panel with one of the lowest emission levels in the industry, complying with Super E<sub>0</sub> level as per AS/NZS 2269 and Japanese Standards.

### 6. What can I do if bubbling occurs?

Plywood bubbling occurs when moisture is trapped underneath the face veneer in an open defect below. When exposed to the sun, this moisture is heated up and if the process is repeated over time, a bubble can occur. This is not necessarily a delamination of the glue line and, as such, should not affect the structural integrity of the panel.

In order to fix the bubble simply remove the portion of the affected face veneer and allow the area to dry fully and use a suitable filler such as builders bog. To minimize potential bubbling we suggest that for all exterior applications the product is well sealed and protected as soon as possible after the installation, before it's exposed to wet weather conditions.

### 7. Do AraucoPly products use genetically modified trees?

ARAUCO products don't use genetically modified trees. All the improvements in ARAUCO's forest quality, productivity and yield are based on the investments in scientific and biotechnological research and development through genetic improvement, soil adaptation and ecosystemic forestry management.

### 8. What are the species used for AraucoPly products?

ARAUCO has forests of different species but the products for Australia and New Zealand are 100% from Radiata Pine.

### 9. What other products does ARAUCO offer?

ARAUCO offers a wide range of products, including Pulp, green and kiln dry Sawn Timber, Millwork products like solid and Finger Joint Mouldings, Preservative Treated Fascias, Posts and Beams, as well as several panel products like Plywood, MDF, Particleboard and Hardboard.

### 10. Does ARAUCO distribute products in Oceania?

ARAUCO sells products to different distributors in Australia and New Zealand, to see the distributors by zone, go to [www.araucopy.com](http://www.araucopy.com), section "Where to Buy".

### 11. Does ARAUCO include the transport of its product to other countries in the Carbon Footprint study?

Yes, ARAUCO Carbon Footprint includes in Scope 3 the transport of its products to the different markets.

### 12. What is the F-rating of AraucoPly?

Our Structural Square-edge and Bracing are rated F8 in accordance to AS/NZS 2269, which includes testing for parallel and perpendicular bending, stiffness, tensile, shear and compression strength. AraucoPly Flooring and Roofing are rated F11, considering its outstanding performance in parallel bending and stiffness strength.

### 13. Are Non-Structural products certified?

Yes, in fact all our Plywood products, except Rejects, are certified under international standards like JAS in Japan, PS1-09 in the USA, CE-EN 13986 in Europe or Keurhout specifically for Holland. Our Non-Structural category is not certified in accordance to Australian and New Zealand standards. The products that meet AS/NZS 2269, like CD or DD Structural Square-edge, Bracing, Flooring or Roofing, are labeled and stamped accordingly.

### 14. Does ARAUCO include indigenous people in their social program?

ARAUCO support programs for the indigenous culture that develops self-sufficiency through traditional crafts with the intent of preserving their cultural traditions and improving their economic standing. These programs include traditional mapuche silver workshop, loom weaving and native trees to be planted in community gardens and training in the care of these trees. The associations that receive support are the *Millaray Mapuche Huilliche Women's Association* and the *Indigenous Women's Association Relmu Wital*.

### 15. Is AraucoPly certified to AS/NZS 2269?

Yes. AraucoPly has been manufactured, tested and audited to meet all requirements of Plywood Structural Standard AS/NZS 2269 in products that are stamped and labeled accordingly, with licenses granted by JAS-ANZ approved SAI Global. License details are available in our web page [www.araucopy.com/loc](http://www.araucopy.com/loc).

### 16. Should you care if a product is certified to AS/NZS 2269?

Yes and no. For applications where the structural integrity of the panel is vital for a project that has been designed using specific structural requirements, we recommend that you use AraucoPly certified to AS/NZS 2269.

For applications where certified product is not required, ARAUCO offers a wide range of alternatives that have not been certified to AS/NZS 2269, however they are certified according to international standards such as the European CE-EN 13986, US PS1-09 or Japanese JAS, manufactured by ARAUCO under strict quality control, offering all the benefits of AraucoPly, such as Strength and Stiffness, Super-E<sub>0</sub> Low Formaldehyde emission, WBP A-Bond glueline and produced from PEFC certified sustainable Radiata Pine plantations.

**17. Who is SAI Global?**

SAI Global is an independent certification organization, recognized globally through the 'five ticks' StandardsMark™ brand, a symbol for reliability, quality assurance and safety. AraucoPly has the privilege to display one of these very highly regarded marks. The recognition in the marketplace gives our certification a cutting edge over competitors who are not certified by SAI Global. For our customers, the StandardsMark™ means that ARAUCO takes quality and safety seriously.

Research surveys indicate that the 'five ticks' StandardsMark™ has 82% general awareness in Australia.

**18. Does ARAUCO cut Rainforest to produce Plywood?**

Absolutely 100% NO. ARAUCO has 3.95 million acres of managed plantation forests and 807 thousand acres of maintained native forests for conservation purposes all certified under PEFC.

**19. What is the Plywood production capacity of ARAUCO?**

ARAUCO has 2 different Plywood Plants in Chile, each one having 2 production lines with a total combined capacity of 700.000 m3 per year. One of them is being reconstructed, and will be completed by the end of 2013. The total Panel production capacity, including Plywood, MDF, Particleboard and Hardboard, is 6.2 million m3 per year.

**20. Is ARAUCO a long term supplier to the Australian and New Zealand market?**

Certainly yes. AraucoPly is known worldwide as one of the leading Softwood Plywood manufacturers, with a presence in more than 40 countries in Asia, Oceania, Europe, USA and Latin America. Our commitment is to provide ALL of our customers with quality products and a continuous service, developing long term relationships with AraucoPly distributors based on respect, honesty and teamwork.

**21. What is the difference between Certified AS/NZS 2269 Structural and Non Certified Plywood?**

Where ever you are using Plywood to form part of the bracing, durability or structural integrity of a building you should always use Certified Structural products. This gives you the assurance that all of the tests and checks have been done to give you confidence that the product will always do the job that it was designed to do. There are however a lot of applications where this is not relevant such as hoardings, building the dog house, lining, the interior wall of a garage and others. For these applications AraucoPly also has various options.

**22. What is a boat patch?**

This is a repair on the face veneer to improve the visual appearance of the product. Instead of a filler being used the imperfection is punched out using a press and a replacement piece of veneer the exact same size is substituted in the shape of a leaf. Once the product is either painted or clear finished it is very hard to see this repair and is a much preferred option.

**23. What does CCA Treatment Stand for?**

CCA stands for Copper, Chromium and Arsenic, it is a waterborne preservative that will usually be green in colour and will give you a H3.2 Treatment Standard. The product is placed in a compression chamber and completely submerged under pressure to force the treatment inside the ply as much as possible, it is then taken out of the chamber, wooden fillets are placed in between each sheet and then placed inside a kiln. The product is then dried to around 18% moisture content to give the product stability. One of the most important things to remember with CCA treatment is that you must reseal any cut edges of the product with a preservative product such as Metalex Green End Seal.

Contact your local distributor for AraucoPly CCA H3.2 treated products availability.

**24. What does LOSP Treatment stand for?**

LOSP stands for Light Organic Solvent Preservative. The biggest difference is that unlike CCA, which is a waterborne wet process LOSP, is a solvent based dry process. LOSP treated plywood gives a H3.1 Standard level of treatment and leaves the ply pretty much with the same look as it was before it was treated. It is an ideal treatment for Claddings and for Soffit Lining. With LOSP treatment the most important thing is that you allow the product to flash off which must be done in a well-ventilated area for at least 48 hours. Although this should always be done prior to the product being sold to the general public, it is always as good idea to allow some time prior to installation to make 100% sure.

Contact your local distributor for AraucoPly LOSP H3.1 treated products availability.

**25. How is Arauco Plywood graded?**

All Plywood is graded with a simple system of ABCD. Basically the A grade is the best and the D grade is the lowest. A CD grade means that one face of the sheet has a C grade ply and the other has a D grade. One side of the sheet will always be the face side and will be sanded a little more smoothly than the other side. The grading itself is done initially by computer where there is a scan done of the face veneer and compared with some set variables to give the grade and then it is also graded by a person just to make sure that the machines were right.

**26. How is Plywood Constructed?**

Plywood is constructed by first peeling a log to a standard veneer thickness and these veneers are glued together with the grain at 90 degrees to each other. This gives the strength and stability that makes Plywood so strong and versatile. These veneers are then pressed together with high heat and pressure, sanded and graded for the end use.

**27. Can I use untreated plywood on the side of my building?**

AraucoPly recommends the use of AraucoPly Cladding, a LOSP treated product with a band sawn face which will give you a great finish that will last for many years.

**28. Should I allow expansion gaps?**

An expansion gap should always be allowed in most cases. A 5mm gap is suggested with using the T&G product and a 2-3mm expansion gap should be allowed when using AraucoPly in a wall Cladding situation.

**29. Should I always ask for Marine Ply for an application that requires exterior glue?**

The answer is yes only if you are using the product in the Marine industry. For most construction uses you are really thinking that the product should be Marine Bonded which is an A-Bond glue line. All AraucoPly products fall into this category so you can be assured of the glue line.

**30. What is surface checking?**

This occurs with all timber that is left outside to weather. It is caused with a combination of sun, rain and wind that wets and dries out the face veneer over time. It is especially prominent on the northern face of a building. It is a normal occurrence with the fibres in the face of the ply and can be minimised with sealing the surface after installation and trying to keep the product as much as possible protected from the elements by using things such as a good soffit size. Surface checking is a normal characteristic of plywood when used outside and does not affect the structural integrity of the product.

## Limitations

The information contained in this document is current as at March 2013.

ARAUCO had made every attempt to ensure the accuracy, reliability and completeness of the information provided in this document and, to the extent permitted by law, will not be responsible for any inaccuracies, omissions or errors in the content or for any decisions made or actions taken in reliance on the information.





# ARAUCOPLY™

*MORE THAN JUST A PRETTY FACE™*

For more information visit:

[www.araucoply.com/oc](http://www.araucoply.com/oc)

[www.arauco.cl](http://www.arauco.cl)

## ARAUCO

Level 6, 90 Mount Street  
North Sydney - NSW 2060, Australia  
PO Box 784

Phone: (61-2) 9956-8874

Fax : (61-2) 9959-5760

E-mail: [araucoaustralia@arauco.cl](mailto:araucoaustralia@arauco.cl)

[www.arauco.cl](http://www.arauco.cl)



PEFC certified

This paper comes from sustainably  
managed forests and controlled sources.

[www.pefc.org](http://www.pefc.org)



**ARAUCO®**  
Growing the Future